

Durable Corporation  
(800) 537-1603

Model: B610-87-A3

MODEL: B610-87-A3

Size  
Projection 6"  
Height 10"

Length:  
-Overall 89"  
-Anchor Holes 87"  
-Rubber 83"  
Angle Size 1/4"X3"X4"X9-1/2"

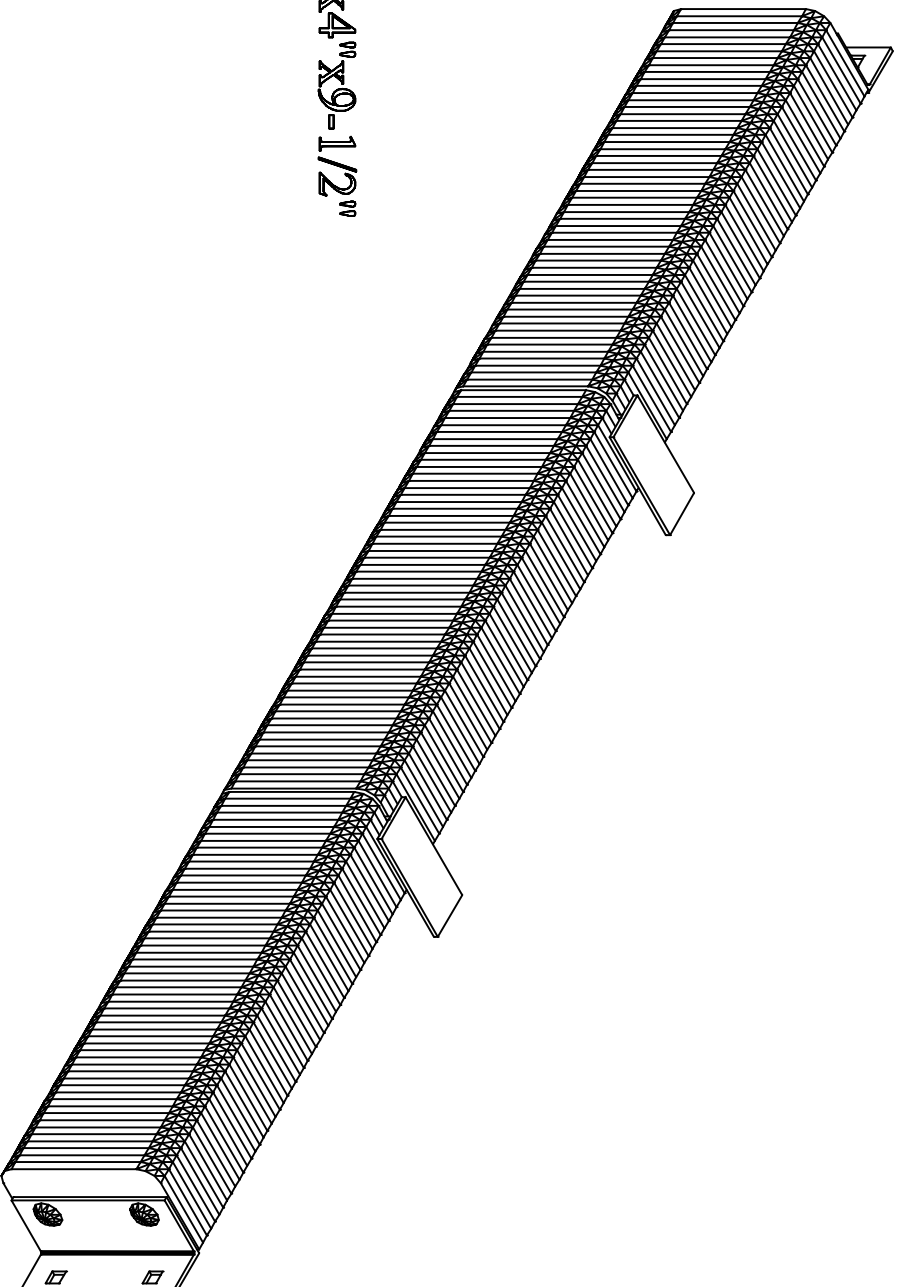

Bolt Heads Are Inscribed  
DURABLE CORP™

Date: 11/02/15

All measurements are +/- 1/8"

Confidential -- Property of Durable Corporation