

Durable Corporation
(800) 537-1603

Model: B610-75-A3

MODEL: B610-75-A3

Size
Projection 6"
Height 10"

Length:
-Overall 77"
-Anchor Holes 75"
-Rubber 71"
Angle Size 1/4" x 3" x 4" x 9-1/2"

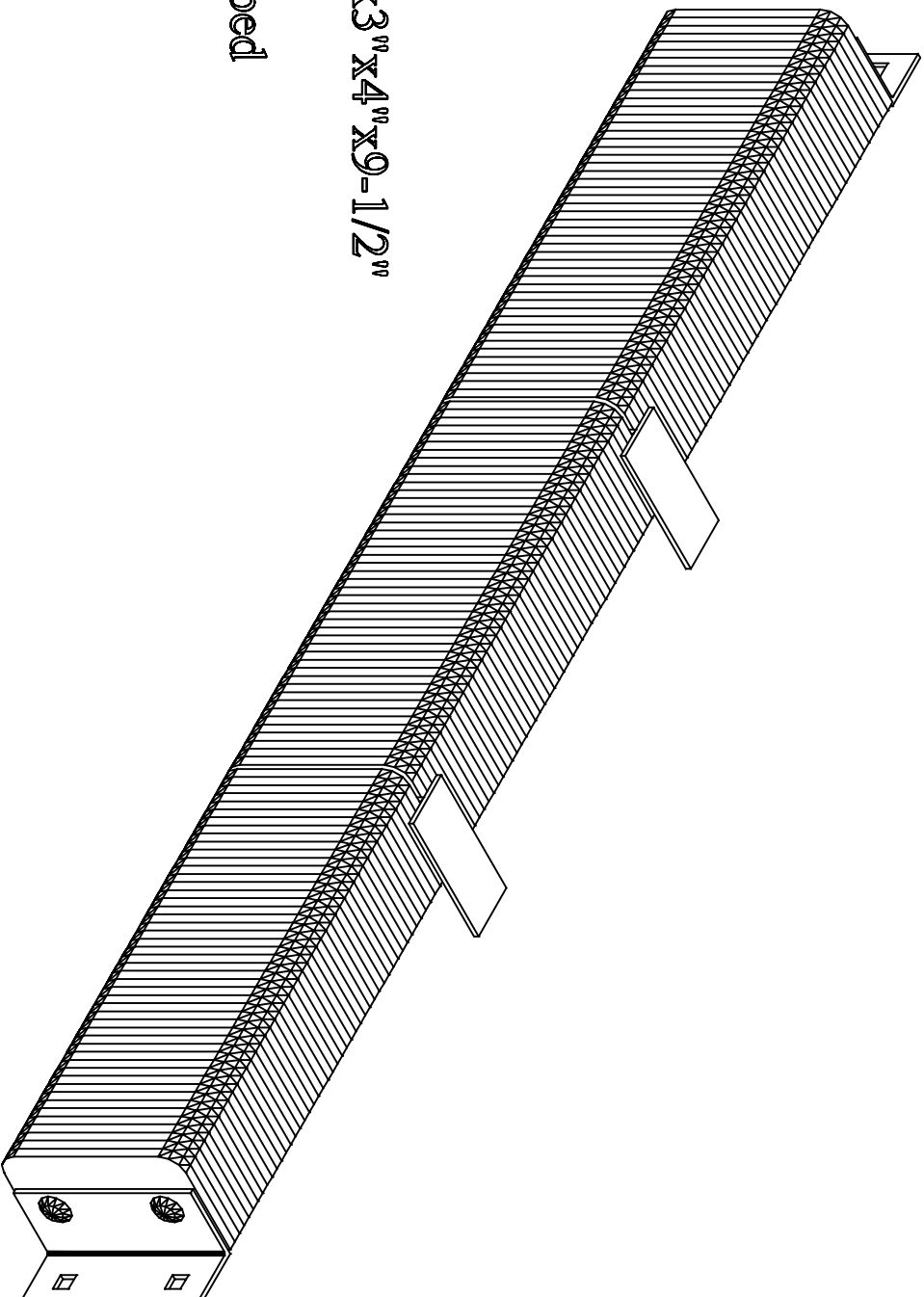

Bolt Heads Are Inscribed
"DURABLE CORP"

Date: 11/02/15

All measurements are +/- 1/8"

Confidential -- Property of Durable Corporation