

Durable Corporation
(800) 537-1603

Model: D-4-18

MODEL: D-4-18
EXTRUDED BUMPER

Size

Overall Length	18"
Overall Thickness	4"
Height	4-3/8"
Bolt Size	1/2 x 3"
Total Weight	9 lbs

Date: 04/07/04
Scale: Full

Please Note:
-Weights are calculated and are not
actual and overall tolerance may vary + or - 1/4.

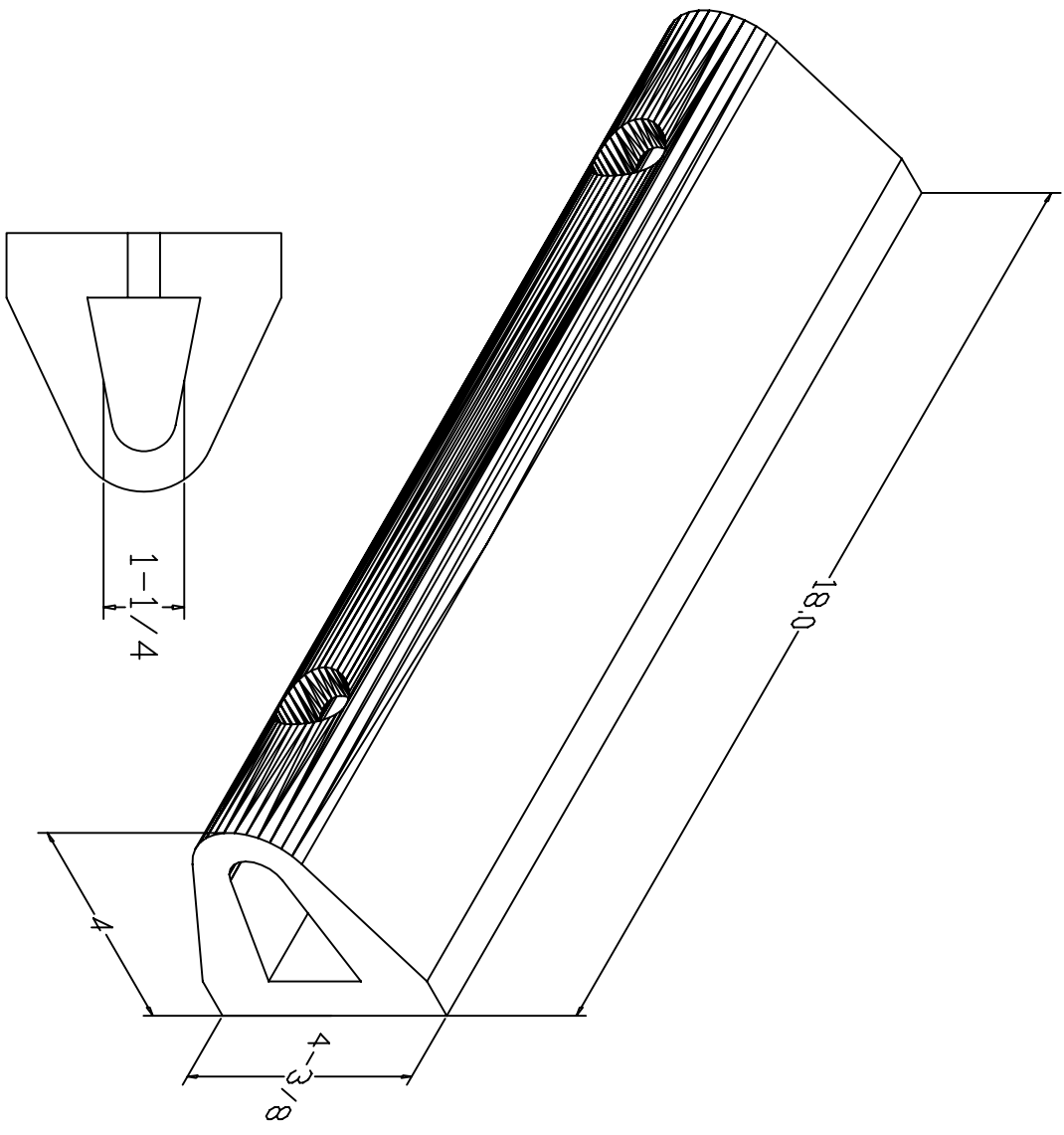

SIDE VIEW